Chapter 1

General Provisions

Article 1.1

INTRODUCTION

1.1.1 Sycamore's Community Vision.

Sycamore's Comprehensive Plan identifies general development goals. The key goals are to:

- ◆ Preserve a small-town identity while promoting expansion of the tax base and community-oriented services and jobs;
- ◆ Maintain the primarily single family character of the community's housing stock;
- ◆ Promote community-oriented commercial retail and service outlets;
- ◆ Retain Sycamore's quality industrial firms and diversify the community's industrial base;
- ◆ Enhance the vitality of the Downtown in terms of aesthetic appearance and commercial activity;
- ◆ Enhance the local economic climate to ensure that Sycamore is a desirable community in which to live, work, and conduct business;
- ◆ Provide exemplary, efficient and cost-effective public services and facilities;
- ◆ Preserve the natural environment as much as reasonably possible during the planning and development of urban land uses and infrastructure.

1.1.2 The Need for this Ordinance.

This Ordinance is intended to serve as a guide for preserving and perpetuating the unique character of the City of Sycamore. It addresses various topics regarding the development and use of land in Sycamore.

The primary purpose of this Unified Development Ordinance is to provide minimum regulations necessary to facilitate safe and orderly growth, and to implement the goals, objectives and policies of the Sycamore Comprehensive Plan. This ordinance will ensure that growth is an integral part of the community and contributes to the formation of compatible neighborhoods and a vital town centers. It will contribute to a community identity to promote civic awareness and responsibility; and it will ensure the greatest possible economic and social benefits for all Sycamore residents and businesses.

To these ends, the Unified Development Ordinance, and related maps, illustrations and diagrams have been prepared with due consideration of future growth; the promotion of a coherent neighborhood-scaled built environment which respects local and regional architecture; the promotion of an integrated and balanced transportation system based on pedestrian, transit and automobile use; the adequate provision of water and sewer infrastructure, schools, parks, and other public necessities; and the preservation and enhancement of the natural environment through the protection and restoration of floodplain, forests, wetlands and careful landscaping of the public realm.

1.1.3. General Development Objectives.

The objective of the Unified Development Ordinance is to carry out and achieve the goals and objectives of the Sycamore Comprehensive Plan. The Comprehensive Plan provides a clear vision of the community's expectations and aspirations, and strategies for orderly development in Sycamore.

1.1.4. Organization of this Document.

The Unified Development Ordinance approaches regulations from the most general to the most specific across the document and within each Chapter, Article, and Section. The document is organized into six Chapters: General Provisions; Decision-Making, Administration and Enforcement Responsibilities; Non-Conformities; Development Review Procedures; Use Districts; and Land Use and Development Standards.

Chapter 1, General Provisions, sets forth all of the regulations affecting the entire Title, including recitals, definitions and legal foundations and is the most general of all the Chapters of the Unified Development Ordinance.

Chapter 2, Decision-Making, establishes the roles and responsibilities for administering and enforcing the regulations in the Unified Development Ordinance.

Chapter 3, Non-Conforming Uses, addresses the issue of non-conforming lots, buildings, structures and uses in the City of Sycamore and how to deal with their eventual elimination.

Chapter 4, Development Review Procedures, outlines the processes, procedures, and application requirements for site plan review, subdivision plats, rezoning, special uses, planned developments and variations.

Chapter 5, Use Districts, establishes all of the various zoning districts in the City of Sycamore and the conditions for establishing special uses in each district. The uses permitted in each District may be found in this Chapter, as well as the performance standards for all land uses in the City of Sycamore.

Finally, in Chapter 6, Land Use and Development Standards, one will find all of the regulations governing the use of signs, landscaping, parking, public utilities, streets, sidewalks, and other public improvements, and development in the floodplain in Sycamore. This Chapter also includes all of the regulations pertaining to the physical design, improvement and development of land and public improvements in and within one and one-half miles of the Sycamore corporate limits, including contribution requirements for land for schools and parks.

Article 1.2

PURPOSE AND APPLICABILITY

1.2.1. Title and Jurisdiction. This Title shall be cited as the "Unified Development Ordinance of the City/Village of Sycamore and shall apply to uses of structures, land and water within the corporate limits of the City of Sycamore and to the subdivision of land and the public improvements placed thereon in and within one and one-half (1-1/2) miles of the corporate limits of the City of Sycamore.

1.2.2. Purpose and Intent. This Title is adopted for the following purposes:

- A. To implement the goals, objectives and policies of the Sycamore Comprehensive Plan.
- B. To promote the public health, safety, morals, comfort and general welfare of the people;
- C. To divide the City of Sycamore into zones or districts regulating and restricting therein the location and use of building, structures and land for residence, business, manufacturing and other specified purposes;

- D. To protect the character and stability of the agricultural, residential, business, and manufacturing areas within the City of Sycamore and to promote the orderly and beneficial development of such areas;
- E. To provide adequate light, air, privacy and convenience of access to property.
- F. To regulate the intensity of use of lot areas, and determine the area of open spaces surrounding buildings that is necessary to provide adequate light and air and to protect the public health;
- G. To establish building lines and the location of buildings designed for residential, business, and manufacturing or other uses within such areas;
- H. To fix reasonable standards to which buildings or structures shall conform therein;
- I. To prohibit uses, buildings or structures incompatible with the character of development or intended uses within specified zoning districts;
- J. To limit congestion in the public streets and protect the public health, safety, convenience and general welfare by providing for the off-street parking of motor vehicles and the loading of commercial vehicles;
- K. To protect against fire, explosion, noxious fumes, and other hazards in the interest of the public health, safety, comfort and general welfare.
- L. To prevent the overcrowding of land and undue concentration of structures, so far as is possible and appropriate in each district, by regulating the use and bulk of buildings in relation to the land surrounding them;
- M. To conserve and enhance the taxable value of land and buildings throughout the City of Sycamore;
- N. To provide for the gradual elimination of non-conforming uses of land, buildings and structures which are adversely affecting the character and value of desirable development in each district;
- O. To prevent additions or alterations or remodeling of existing buildings or structures in such a way as to avoid the restrictions and limitations lawfully imposed herein;
- P. To facilitate and insure the preservation of sites, areas and structures of historical, architectural and aesthetic importance;
- Q. To define and limit the powers and duties of the administrative officers and bodies provided herein;
- R. To encourage the orderly and beneficial development of the community through appropriate growth management techniques assuring the timing and sequencing of development, and the promotion of infill development in existing neighborhoods and non-residential areas with adequate public facilities;
- S. To guide public and private policy and action in order to provide adequate and efficient transportation, water, sewerage, schools, parks, playgrounds, recreation, and other public requirements and facilities;
- T. To provide the most beneficial relationship between the uses of land and buildings and the circulation of traffic throughout Sycamore, with a particular regard to the avoidance

of congestion in the streets and highways and the pedestrian traffic movements appropriate to the various uses of land and buildings, and to provide for the proper location and width of streets and building lines;

- U. To establish reasonable standards of design and procedures for subdivisions and resubdivisions in order to further the orderly layout and use of land, and to ensure proper legal descriptions and monumenting of subdivided land;
- V. To ensure that public facilities and services are available concurrent with development and will have a sufficient capacity to serve the proposed subdivision or development and that the community will be required to bear no more than its fair share of the cost of providing the facilities and services through requiring developers and subdividers to pay fees, furnish land, or establish mitigation measures to ensure that the development or subdivision provides its fair share of capital facility needs generated by the development or subdivision;
- W. To preserve the natural beauty and topography of Sycamore and to ensure appropriate development with regard to these natural features;
- X. To prevent the pollution of air, streams, and other surface waters; to assure the adequacy of drainage facilities; to safeguard the water table, and to encourage the wise use and management of natural resources throughout Sycamore in order to preserve the integrity, stability, and beauty of the community and the value of land;
- Y. To preserve the character and quality of Sycamore neighborhoods by maintaining the integrity of those areas which have a discernible character and are harmonious in design;
- Z. To prescribe penalties for the violation of, and methods for the enforcement of, the provisions of this Title or any amendment thereto.
- AA. To protect new building and major improvements from flood damage, and to make federally subsidized flood insurance available for property in the City of Sycamore by fulfilling the requirements of the National Flood Insurance Program.

1.2.3. Separability. In accordance with the following, it is hereby declared that the several provisions of the Title are separate:

- A. If any court of competent jurisdiction determines any provision of the Title to be invalid, such determination shall not affect any other provision of this Title, not specifically included in the court's judgment order.
- B. If any court of competent jurisdiction determines any provision of the Title to be invalid as applied to a particular lot, parcel, building, structure or use, such determination shall not affect the application of such provision to any other lot, parcel, building, structure or use not specifically included in the court's judgment order.

1.2.4. Repeal of Conflicting Ordinances. This ordinance is expressly adopted pursuant to the Home Rule Powers of the City of Sycamore under Section 6 of Article VII of the Illinois Constitution of 1970. All ordinances or parts of ordinances in conflict with this Ordinance are repealed insofar as they conflict.

The Amended Zoning Ordinance of 2001, which had amended the Zoning Ordinance of 1984, which had amended sections 197 through 264 of Chapter XXII of the revised and compiled ordinances of the City of Sycamore, printed and published by the authority of the City Council pursuant to an ordinance passed on November 12, 1934, shall be deleted. The zoning and development provisions incorporated herein shall be inserted in their place.

- 1.2.5. Publication and Effective Date.** By authority of the Mayor and City Council, this Unified Development Ordinance shall be printed in pamphlet form and copies thereof shall be available at the Office of the City Clerk. This Title shall be in full force from and after its passage, and upon approval and publication in the manner provided by law.
- 1.2.6. Illustrations.** The illustrations used in the Title are not drawn to scale and are intended only to graphically represent the requirements and concepts contained herein, and are not intended, nor should they be construed, to represent every situation or circumstance which may exist in the City of Sycamore. When there is a conflict between the text of the Unified Development Ordinance and an illustration herein, the text shall prevail.
- 1.2.7. Zoning Map.** The location and boundaries of the Districts established by this Title are indicated upon the map entitled, "Official Zoning Map, City of Sycamore Illinois," which, together with all explanatory matter thereon, is hereby adopted by reference and declared to be a part of this Unified Development Ordinance. The Official Zoning Map shall be on file in the City Clerk's Office and shall be the final authority as to the current zoning status of land and buildings, subject to such authorized amendments, which may be in effect.
- 1.2.8. Official Map.** The location of all existing and future streets, highways, parks, public grounds and public ways, including, but not limited to schools, bicycle trails, municipal parking areas, public works garages and facilities, wastewater treatment plants, and wells, laid out, adopted and established by this Title are indicated upon the map entitled "Official Map of the City of Sycamore," which together with all explanatory matter thereon, is hereby adopted by reference and declared to be a part of this Unified Development Ordinance. The Official Map shall be on file in the City Clerk's Office. All annexation plats and subdivision plats which may hereafter be approved by the Mayor and City Council of the City of Sycamore and recorded in the Office of the Recorder of Deeds of DeKalb County shall be, and such annexation and subdivision plats are hereby designated, a part of the Official Map of the City of Sycamore.
- 1.2.9. Annexed Land.** All territory which may hereafter be annexed to the City of Sycamore, shall be classified R-1 Single Family District until otherwise classified by amendment as provided herein. In the event owners requesting annexation of their property desire a classification other than R-1 Single Family District, a petition shall be submitted for the desired zoning classification simultaneously with the petition for annexation.
- 1.2.10. Boundary Lines.** In the event that uncertainties exist with respect to the intended boundaries of the various districts as shown on the Zoning Map, the following rules shall apply:
- A. District boundaries are the centerlines of the streets or alleys, unless otherwise indicated. Where designation of a boundary line on the Zoning Map coincides with the location of a street or alley, the centerline of such street or alley shall be construed to be the boundary of such district.
 - B. Where the district boundaries do not coincide with the location of streets or alleys, but do coincide with lot lines, such lot lines shall be construed to be the boundary of such district.
 - C. Where the district boundaries do not coincide with the location of streets, alleys, or lot lines, the district boundary shall be determined by the use of the scale shown on the Zoning Map.
 - D. When a lot held in one ownership on the effective date of this Title is divided by a district boundary line, the entire lot shall be construed to be within the more restrictive district.
 - E. All streets, alleys, public-ways, and railroad rights-of-way, if not otherwise specifically designated, shall be deemed to be in the same zone as the property immediately abutting

upon such alleys, streets, public-ways and railroad rights-of-way. Where the center line of a street, alley, public-way or railroad rights-of-way serves as a district boundary, the zoning of such areas, unless otherwise specifically designated, shall be deemed to be the same as that of the property abutting up to such center line.

- F. Boundaries indicated as approximately following municipal boundary limits shall be construed to follow municipal boundary limits.
- G. Boundaries indicated as following railroad rights-of-way shall be construed to be midway between the rights-of-way.
- H. Boundaries indicated as approximately following the center lines of streams, rivers, lakes, or other bodies of water shall be construed to follow such center lines.
- I. Streets, alleys, public ways or railroad rights-of-way which are shown on the zoning map and which have heretofore been vacated, or which may be vacated hereafter, shall be in the same district as the land abutting both sides of the street, alley, public way or railroad right-of-way involved. If the land abutting each side of the street, alley, public way or railroad right-of-way, was located in different districts before the said street, alley public way or railroad right-of-way was vacated, the center line of such vacated street, alley, public way or railroad right-of-way shall be the district boundary line of the respective zoning districts.

1.2.11. Interpretation.

- A. In their interpretation and application, the provisions of this Title shall be held to be the minimum requirements for the promotion of the public health, safety, morals and welfare.
- B. Where the conditions imposed by any provision of this Title upon the use of land or buildings or upon the bulk of buildings are either more restrictive or less restrictive than comparable conditions imposed by any other provisions of this code or of any other law, ordinance, resolution, rule or regulations of any kind, the regulations which are more restrictive (or which impose higher standards or requirements) shall govern.
- C. Nothing in this Title shall be deemed to be a consent, license or permit to use any property, to locate, construct, or maintain any building, structure or facility, or to carry on any business, industry, occupation or trade.

1.2.12. Platted Building and Setback Lines. If a recorded subdivision plat imposes a building or setback line for a lot which is less than the minimum yard required by the applicable section of this Title, then, notwithstanding the recorded plat, the minimum yard shall be the same as required by the applicable section of this Title.

1.2.13. Incorporation by Reference. Any and all standards and other codes, regulations and public records incorporated by reference into this unified development ordinance have been adopted in accordance with the requirement established in Chapter 65, Act 5, Section 1-3-1 *et seq.* and Chapter 50, Act 220, Section 1001 *et seq.* of the Illinois Compiled Statutes.

1.2.14. Disclosure by Trustee of Land Trust. Whenever any trustee of a land trust or any beneficiary or beneficiaries of a land trust make application to the City of Sycamore or any of its agencies pursuant to the provisions of this Title relating to the land which is the subject of trust, any interest therein, improvements thereto, or use thereof, such application shall identify each beneficiary of such land trust by name and address and define his interest therein. All such applications shall be verified by the applicant in his capacity as trustee, or by the beneficiary as the beneficial owner of an interest in such land trust.

1.2.15. Successor to Rule or Standard Making Agencies. Whenever a governmental or private agency is referred to as the promulgator of a rule or standard, the rule or standard shall continue to be incorporated by reference within this Title in the event that the same rule or standard is adopted by a successor agency in name or substance.

1.2.16. Private Agreements. This Title is not intended to abrogate any easement, covenant, or other private agreement; provided, that where the regulations of this ordinance are more restrictive or impose higher standards or requirements than easement, covenants, or other private agreements, the requirements of this ordinance shall be controlling.

Article 1.3

DEFINITIONS

1.3.1. Use of Definitions. In the construction of this code, the definitions contained in this article shall be observed and applied, except when the context clearly indicates otherwise;

1.3.2. Rules. In the construction of this Title, the rules contained in this Article shall be observed and applied, except when the context clearly indicates otherwise.

- A. Words used in the present tense shall include the future; and words used in the singular number shall include the plural number, and the plural, the singular.
- B. The words "shall" and "will" are mandatory and not discretionary.
- C. The word "may" is permissive.
- D. The word "lot" shall include the words "plot", "piece", and "parcel".
- E. Unless otherwise specified, all distances shall be measured horizontally.
- F. Whenever a word or term defined hereinafter appears in the text of this Title, its meaning shall be construed as set forth in the definition thereof.
- G. The masculine gender shall include the feminine and neuter.
- H. All measured distances shall be expressed in feet and shall be calculated to the nearest tenth (0.10) of a foot.
- I. The word "person" shall include the words "association", "corporation", "estate", "governmental agency", "individual", "joint venture", "partnership", "venture", or any other legal entity.
- J. The word "building" shall include the word "structure".
- K. The phrase "used for" shall include the phrases "arranged for", "designed for", "intended for", "maintained for", and "occupied for".

1.3.3. Definitions. The following words and terms when used in the interpretation and administration of this Title shall have the meaning set forth herein except where otherwise specifically indicated. Words and terms not defined here shall be defined as specified in the latest published edition of Webster's New Collegiate Dictionary.

Accessory Structure (Use): shall mean a structure (use) customarily incidental to and auxiliary to the use of a principal structure (use) on the same premises with such principal structure (use). When the wall of an

accessory structure is a part of or joined to the wall of the principal structure such accessory structure shall be construed as a part of the principal structure.

Adult Care Center: shall mean a building or group of buildings providing daytime care to six (6) or more handicapped persons or senior citizens unrelated by blood or marriage, and not legal wards or foster children of the attendant adult within an occupied residence.

Adult Use: See Section 4.3.4 herein.

Agribusiness: shall mean agriculturally related businesses such as, but not limited to, anhydrous ammonia facilities, bulk fertilizer facilities, grain elevators, grain storage, sale and repair of farm implements; liquid petroleum products; animal feed storage; seed research and production; sales of seed, wholesale and retail; preparation, grinding and mixing, wholesale and retail; and livestock depots and buying or sale yards.

Agriculture: shall mean land, or land and structures, which is primarily used and intended for one or more of the following: the growing of farm crops, truck garden crops, animal and poultry husbandry, apiculture, aquaculture, dairying, floriculture, horticulture, nurseries, tree farms, sod farms, pasturage, viticulture, wholesale greenhouses; and, accessory uses customarily incidental to agricultural activities. Any and all land use in accordance with the above shall be considered to be used for agricultural purposes.

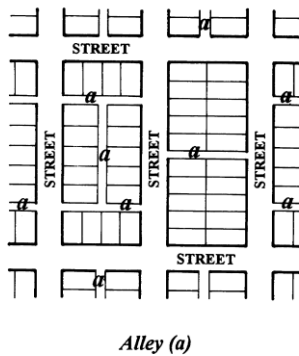

Alley (a)

Alley: shall mean a public or private way primarily designed to serve as a secondary means of access to those parcels whose principal frontage is on a public street.

Alterations, Structural: see structural alteration.

Amusement Arcade: shall mean an establishment devoted to the use of four (4) or more coin-operated amusement devices.

Animal Foster Home: shall mean any private premises or portion thereof on which animals belonging to a state licensed animal shelter are housed until adoption.

Animal Hospital: shall mean a place where animals are given medical or surgical treatment and the boarding of animals is limited to short-term care incidental to the hospital use.

Animal Shelter: shall mean any space designated to provide for the temporary accommodation of five (5) or more common household pets which are stray or not wanted by their owner, until appropriate disposition or adoption of such pets can be effectuated.

Antenna: shall mean an arrangement of wires, metal rods, parabolic or concave dishes, or similar materials used for the transmission and/or reception of electromagnetic waves.

Antenna Tower: shall mean any structure designed for the purpose of mounting an antenna.

Apartment: shall mean a room or suite of rooms in a multiple dwelling structure, which is arranged, designed, used or intended to be used as a residence for one family.

Apartment Hotel: shall mean a building or portion thereof designed for or containing both individual guest rooms or suites of rooms, and dwelling units, the majority of which are for permanent guests. Maid and janitor service may be provided but kitchen facilities are not necessarily included.

Arbor: shall mean a leafy, shady recess formed by tree branches, or latticework intertwined with shrubs or vines.

Arcade: shall mean a building frontage type where the building façade above the ground level overlaps the public sidewalk while the ground level portion of the building maintains a setback or is located at the build-to line.

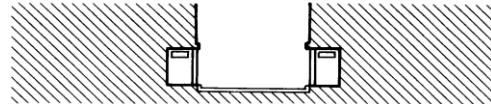

Arcade

Artwork: shall mean any object, such as a sculpture, figure, statue, monument, painting, photograph or the like constructed out of such materials as stone, clay, wood, or metals, which exhibits individual expression and creativity.

Arts and Recreation Center (Indoor): shall mean any recreational use conducted entirely within a building, including an art gallery and studio, art center, assembly hall, community center, dance instruction, exhibit hall, gymnasium, library, museum, musical instruction, skating rink, sporting practice and instruction, swimming pool, tennis court. (2014.19, 10-20-2014)

Assisted Living: shall mean an apartment-type residential living facility that provides limited supervision and care for the residents of the facility.

Awning: shall mean a roof-like cover that is temporary in nature and that projects from the wall of a building for the purpose of shielding a doorway or window from the elements. A canopy is another type of roof-like structure, either temporary or permanent, supported in whole or in part by vertical supports and which, in the “C-2” Central Business District, may overhang a public way so long as it complies with the provisions of this Ordinance.

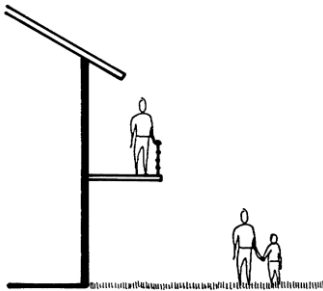

Balcony

Balcony: shall mean an elevated platform open to the elements, not supported by the ground and projecting from an upper story and enclosed entirely by a railing.

Bar: shall mean a licensed establishment where alcoholic beverages served for consumption on the premises constitute eighty percent (80%) of the gross annual receipts for alcoholic beverages. Bars may also sell packaged liquors, but under no circumstances may a bar be converted to a package goods store unless under the authority of the Liquor Control Commissioner and the City Code.

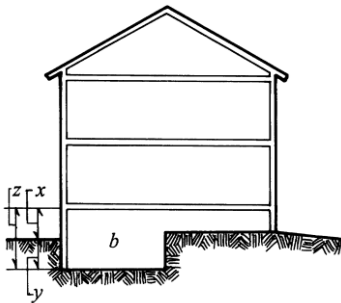

Basement (b),

Where $x > y$ and $z \leq 14$ feet

Basement: that portion of a building that is partly or completely below grade plane. A basement shall be considered as a story above grade plane where the finished surface of the floor above the basement is:

- More than 6 feet above grade plane; or
- More than 12 feet above the finished ground level at any point.

Bay Window: shall mean a window projecting beyond the wall line of the building and not supported by a foundation.

Bed and Breakfast Lodge, Inn: shall mean a licensed residential building containing not more than five (5) lodging rooms offered for rent on a daily basis to transient guests for a continuous period of thirty (30) days or less, and containing the owner's principal residences; where provision of meals is limited to the breakfast meal served exclusively to overnight guests between the hours of 5:00 A.M. and 10:00 A.M.

Bedroom: shall mean any room designed, intended, or used principally for sleeping purposes.

Berm: shall mean soil of good quality, un-compacted, raised generally above the surrounding finish grade with side slopes generally no steeper than three (3) horizontal units to one (1) vertical unit (3:1); generally a man-made slope.



Block: shall mean a tract of land bounded by streets, or by a combination of streets and public parks, cemeteries, railroad right-of-way, municipal, township and county boundary lines.

Body Shop or Motor Vehicle Repair: shall mean any building or portion thereof used for the repair or straightening of a motor vehicle body or frame, the painting of motor vehicles, or the maintenance, service and repair of engines.

Breezeway: shall mean a covered pedestrian passageway, as between a house and a garage, but otherwise exposed to the elements.

Brewpub: shall mean an establishment where beer and malt beverages are made on the premises in conjunction with a restaurant or bar and where 40% or more of the beer produced on site is sold on site.

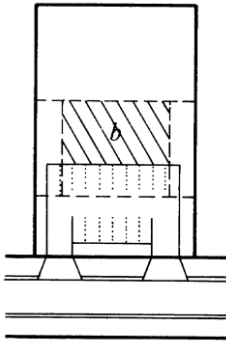

Buildable Area (b)

Buildable Area: shall mean the area of a lot or parcel remaining after yard, parking or any other requirements of this ordinance have been satisfied.

Building: shall mean a roofed, structure designed or intended for the enclosure, shelter or protection of persons, animals or other property. All forms of vehicles, even if immobilized, are excluded from this definition.

Building Coverage: shall mean the area of a zoning lot occupied by the principal building(s) and accessory structures.

Building Line: shall mean a line parallel to adjacent property lines at a specified distance from said property lines establishing the minimum open space to be provided between building(s) and an adjacent lot line. Also known as "building setback line" or "setback line."

Building Height: shall mean the vertical distance of a building measured at the midpoint of the front wall of a building between the finished grade at the front wall of the building and the average height of the highest roof surface, excluding chimneys, mechanical equipment, cooling towers, storage tanks, bulkheads, spires, water towers, and antennae attached to or resting upon the building.

Bulk: shall be the term used to describe the size and mutual relationships of buildings and other structures as to size, height, coverage, shape, location of exterior walls in relation to lot lines, to the center line of streets, to other walls of the same building, and to all open spaces relating to the building or structure.

Burial Building: shall mean any building used for the interment of bodies or other remains of persons who have died, including mausoleums, vaults, or columbaria.

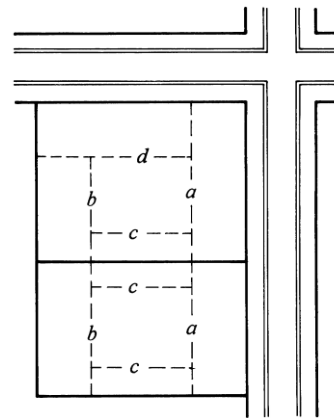

Building Lines (Setbacks)

Where *a* = Front Building Line
b = Rear Building Line
c = Side Building Line
d = Corner Side Building Line

Business: shall mean an occupation, employment, or enterprise which occupies time, attention, labor and materials, or wherein merchandise is exhibited, bought or sold, or where services are offered for compensation.

Caliper: shall mean the diameter of a tree trunk six (6) inches above the existing grade or proposed planted grade and in conformance with the provisions of the Code of Standards (Z60.1-1986 or latest version) published by the American Association of Nurserymen, Inc.

Cannabis, Recreational – Retail Dispensing Organization (Adult Use): A facility operated by an organization or business that is licensed by the Illinois Department of Financial and Professional Regulation to acquire cannabis from licensed cannabis business establishments for the purpose of selling or dispensing cannabis, cannabis-infused products, cannabis seeds, paraphernalia or related supplies to purchasers or to qualified registered medical cannabis patients and caregivers, per the Cannabis Regulation and Tax Act, (P.A. 101-0027), as it may be amended from time-to- time, and regulations promulgated thereunder.

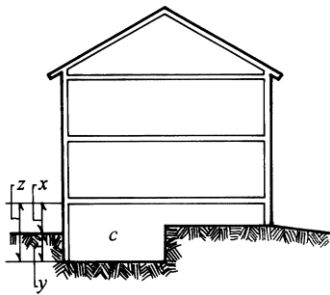

*Cellar (c),
Where $x < y$ and $z \leq 14$ feet*

Car Wash: shall mean a structure, or portion thereof, containing facilities for washing automobiles, and may utilize production-line methods using a conveyor, blower, steam-cleaning device; or other mechanical devices, and may include detailing services.

Cellar: shall mean a space within a building with less than one-half of its floor-to-ceiling height above the average finished grade of the adjoining ground or with a floor-to-ceiling height of less than six and one-half (6.5) feet.

City: shall mean the City of Sycamore an Illinois municipal corporation.

Clinic: see **Dental Clinic** and **Medical Clinic**.

Club or Lodge: shall mean a group of people organized for a common purpose to pursue common goals, interest, or activities and usually characterized by certain membership qualifications, payment of dues, regular meeting and constitution and by-laws.

Cluster: shall mean plant material installed as a clump or group as opposed to individual specimens. An odd number of shrubs is desired.

Commercial Use: shall mean an activity carried out for pecuniary gain.

Country Club: shall mean a land area and building containing recreational facilities, clubhouse and usual accessory uses, typically open only to members and their guests for a membership fee.

Commercial Recreation: shall mean any establishment or use of land which provides active recreational opportunities, including but not limited to, waterslides and water parks, batting cages, miniature golf, go-cart racing, and the like.

Condominium: shall mean an estate in real property consisting of an individual interest in common with other purchasers in a portion of real property, together with a separate interest in space in a building and/or separate interest in other portions of such real property.

Conservation District: The area bounded by the following streets:

Start at Sacramento Street and State Street and proceed east on State Street to Main Street, including properties fronting the east side of Sacramento Street, the north and south sides of State Street and the west side of Main Street. Rear facades or corner facades facing side streets are not included.

Convalescent Home or Rest Home: shall mean an establishment for the care of the aged or infirm, or a place of rest for those suffering bodily disorders, but excluding contagious or communicable diseases and excluding surgery.

Conventional Energy System: shall mean an energy system utilizing fossil fuel, nuclear, or hydroelectric energy and components of such system, including transmission lines, burners, furnaces, tanks, boilers, related controls, distribution systems, room or area units, and other components.

Cottage: shall mean a room or group of rooms meeting habitable room sizes as required by the locally-adopted building code which are arranged, designed, used and intended for use as living quarters for one household, including sleeping, cooking, eating and sanitation facilities, and may be located in a free-standing accessory building and having its own exterior entrance.

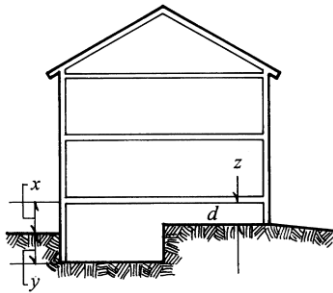

*Crawl Space (d),
where $x < y$ and $z \leq 4.5$ feet*

Crawl Space: shall mean a space between the floor of one story and the floor of the next story above, which normally contains pipes, ducts, wiring and lighting fixtures and permits access but is too low for an individual to stand. A crawl space may be a cellar area no more than four and one-half (4.5) feet in height, or, if between a ceiling and a shed roof or a flat roof, a cockloft.

Cul-de-sac: Shall mean a short street having one end open to traffic and being terminated at the other end by a vehicular turn-around.

Day Care Center: shall mean a facility commonly called "infant and toddler centers", "child care centers", "day nurseries", "nursery schools", "play groups", "kindergartens", and "after school programs for young school age children" licensed by the Illinois Department of Children and Family Services.

Day Care Home: shall mean a residence licensed by the Illinois Department of Children and Family Services for the care of at least three (3) but not more than twelve (12) children for less than twenty-four (24) hours per day. The maximum number of children permitted includes the family's natural, foster or adopted children and all other persons under the age of twelve. The term does not include residences or facilities which receive only children from a single household.

Deciduous: shall mean plants which do not retain leaves or needles during the winter season of the year.

Deck: shall mean a level, unenclosed platform serving as a floor and located above the finished grade, and usually directly adjoining or attached to a building.

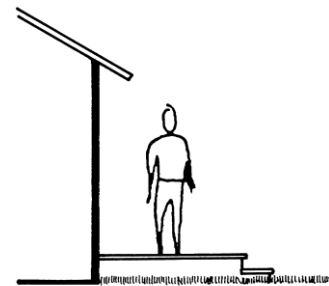

Deck

Dental Office/Clinic: shall mean an establishment where two or more licensed doctors of dentistry engage in the practice of dentistry, operating on a group or individual basis with pooled facilities such as coordinated laboratory, x-ray and allied departments, for the diagnosis and treatment of humans.

Disability: shall mean a personal condition which is: (i) attributed to mental, intellectual, or physical impairment or a combination of mental, intellectual, or physical impairments; (ii) likely to continue for a significant amount of time or indefinitely; and, (iii) results in functional limitation in three or more of the following areas of major life activities or self-care: expressive language; learning; mobility; self-direction; capacity for independent living; or economic self-sufficiency; and reflects the person's need for a combination and sequence of special interdisciplinary or generic care treatment, or other service of life-

long or extended duration, but is not the result of a communicable disease or substance abuse or alcohol abuse.

District, Zoning: shall mean a section of the corporate areas of the City of Sycamore within which the regulations governing the use of land are uniform.

Dog Run: shall mean an enclosed outdoor area intended for the exercising and/or containment of dogs or other animals.

Dooryard: shall mean a building frontage type where the building façade is set back from the frontage line and the space between the frontage line and the building façade is elevated.

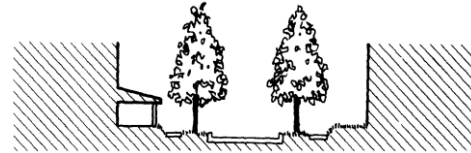

Door Yard

Dormitory: shall mean a building where sleeping accommodations, dining facilities, and common bathroom facilities are provided for more than ten (10) unrelated individuals, exclusive of the resident family, who are students or members of a religious order, college, university, convent, monastery or other institutional use.

Downtown District: The area bounded by the following streets including the properties with frontage on said streets as described herein:

Start at High Street and DeKalb Avenue and proceed east on High Street, including the properties fronting on the south side of High Street, to Locust Street; then north on Locust Street, including properties fronting on the east side of Locust Street, to Exchange Street; then west on Exchange Street, including properties fronting the north side of Exchange Street, to Sacramento Street, then south on Sacramento Street, including properties fronting the west side of Sacramento Street, to DeKalb Avenue; then southwesterly to the point of beginning.

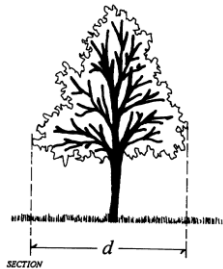

Drip Line: shall mean the zone lying between the trunk of a tree or shrub and the extreme outer edge of the leaf and branch structure, i.e., the diameter of the leaf and branch structure extended vertically down to the soil surface.

Drive-Up Facility: shall mean a facility or establishment which is designed, intended or used for transaction of business with customers in automobiles. A drive-up facility may be the principal or an auxiliary function of the business. A drive-up facility does not include mail or parcel collection boxes.

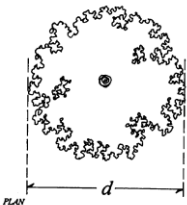

Driveway: shall mean a private roadway providing vehicular access from a street or alley to adjacent property.

Dwelling: shall mean a building or portion thereof designed or used exclusively for residential occupancy, including single-family, two-family, and multiple-family dwellings, but not including hotels, motels or lodging houses.

it: shall mean a building or portion thereof in which a dwelling unit or a portion thereof is located above or below another dwelling unit, or above or below any other independently used portion of the building.

Dwelling, Attached Single-Family: shall mean a building consisting of dwelling units each of which is attached by common vertical wall to at least one other dwelling unit with each dwelling unit having a separate exterior entrance and occupying the ground, including, but not limited to, the following: "townhouse", "rowhouse", "duplex", "four-plex", "three-plex". In addition, no dwelling unit or portion thereof within an attached dwelling shall be located above or below another dwelling unit, and each dwelling unit shall have its primary access to the outside on the ground floor.

Dwelling, Detached Single-Family: shall mean a free-standing building containing one dwelling unit.

Dwelling, Duplex: shall mean a building containing two (2) dwelling units where one (1) dwelling unit is joined with the other dwelling unit on one (1) side by a common wall. No dwelling unit or portion thereof within a duplex dwelling shall be located above or below another dwelling unit. Each dwelling unit shall have an exterior access located on the ground floor.

Dwelling, Efficiency: shall mean a dwelling unit consisting of not more than one habitable room together with cooking and sanitary facilities.

Dwelling, Farm: shall mean a detached single-family dwelling unit located on land used primarily for agricultural purposes, which is used or intended for use by the person engaged in the agricultural use of the subject property.

Dwelling, Multiple-Family: shall mean a building consisting of three (3) or more dwelling units with varying arrangements of entrances and party walls and one or more of the dwelling units that do not occupy the ground, including but not limited to the following: "apartment", "condominium", "cooperative", "manor home", "coach house", "three-flat", and so forth.

Dwelling, Rooming House: shall mean a building or a portion thereof utilized as a dwelling unit which is the primary residence of the owner and which contains lodging rooms for occupancy at a monthly rate of compensation by permanent residents who are not related to the owner. A rooming house maintains a common household. Rooming house dwellings include boarding houses and lodging houses, but exclude residential care facilities.

Dwelling, Two-Family: shall mean a building consisting of two (2) dwelling units where one dwelling unit is located on the first floor and the second dwelling unit is located on the second floor and each dwelling may or may not have a separate exterior entrance.

Dwelling Unit: shall mean one or more rooms, including at least one complete permanently installed bathroom and not more than one complete kitchen facility arranged, designed, or used as a living quarters for not more than one family. Each dwelling unit shall have an independent entrance, cooking, sleeping and sanitary facilities.

Easement: shall mean a grant by a property owner for the use of a strip or parcel of his land by the general public, a corporation, or a certain person(s) for a specific purpose(s).

Eave: shall mean the projecting lower edges of a roof, overhanging the wall of a building.

Evergreen: shall mean plants which continuously retain leaves or needles over four seasons of the year.

Extended Care Facility: shall mean an institution or a distinct part of an institution which is licensed or approved to provide health care under medical supervision for twenty-four (24) or more consecutive hours to two or more patients.

Fabric Structure: shall mean an engineered structure consisting of a structural steel frame protected by a fabric cover that meets all flame resistant, fire retardant and natural force requirements.

Façade: shall refer to matters of spatial definition and shall mean the vertical surface of a building set along a frontage line. Facades are subject to visual definition by building height, setback lines, recess lines, and transition lines.

Family: shall mean one or more persons related by blood or marriage, or adoption, or not more than three persons (excepting servants) who are not related by blood, marriage or adoption, using common cooking

facilities and living and eating together on the premises as a single housekeeping unit. **Exception:** Group Homes (see below).

Farm: shall mean any real property used for commercial agricultural purposes.

Fence: shall mean a free standing structure of metal, masonry, or wood or any combination thereof permanently installed by being partially buried in the ground and rising above ground level, and used for confinement, screening, or partition purposes, including the following: (i) *Open Fence*; a fence having a regular pattern that has thirty-five percent (35%) or more of the surface open with a minimum opening of one inch (1") and unobstructed to vision, light and air, when viewed perpendicular to the plane of the fence and intended primarily for aesthetic purposes; and (ii) *Privacy Fence*; a fence having a regular pattern that has less than thirty-five percent (35%) of the surface open and unobstructed to vision, light and air, when viewed perpendicular to the plane of the fence and intended primarily for privacy or security purposes.

Festoon Lighting: shall mean a group of two or more incandescent light bulbs hung or strung overhead, or on a building or structure, which are exposed to persons on a public right-of-way, or which are not shaded or hooded to prevent the direct rays of light from being visible from the property line.

Floor Area, Gross(GFA): shall mean the sum of the gross horizontal areas of the several floors of the building measured from the exterior faces of the exterior walls or from the center line of walls separating two buildings, without deduction for hallways, stairs, closets, thickness of walls, columns or other features. It shall include attic space having headroom of seven feet, ten inches (7'10") or more; interior balconies and mezzanines; enclosed porches; and interior off-street parking and loading facilities.

Floor Area, Net (NFA): shall mean the actual occupied area of the several floors of a building and shall not include unoccupied accessory areas or wall thicknesses. It shall include attic space having headroom of seven feet, ten inches (7'10") or more.

Floor Area Ratio (FAR): shall mean the gross floor area of the building or buildings measured from the exterior faces of the exterior walls or from the center line of walls separating attached buildings, on that lot divided by the area of such lot, or in the case of planned unit developments, by the net site area.

Food Store: shall mean an establishment where the principal use is the retail sale of food, including meats, produce, bakery and dry goods, and may include accessory preparation of food for consumption on or off the premises.

Forecourt: shall mean a building frontage type where the building façade is set back and is replaced with a low wall at the frontage line.

Fraternal Organization: shall mean a group of individuals formally organized for a common interest, usually cultural, religious, or entertainment, with regular meetings and formal written membership requirements.

Front Lawn: shall mean a building frontage type where the building façade is set back substantially from the frontage line and is uninterrupted by fences, porches and other structures.

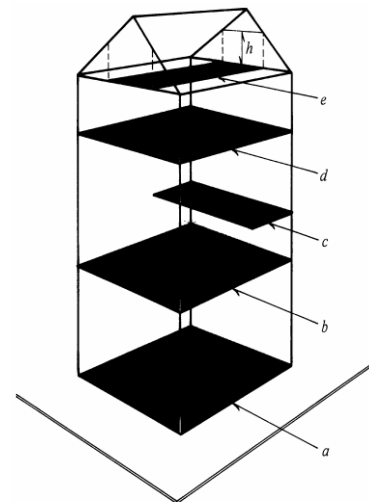

Floor Area
 $Floor Area = a + b + c + d + e$
 (include e only if $h \geq 7'10''$)

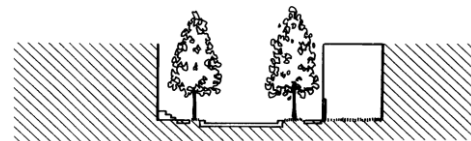

Forecourt

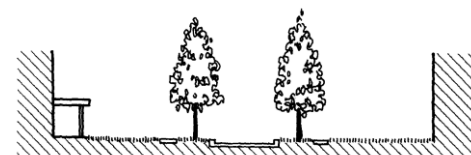

Front Lawn

Garage, Private: shall mean a building, or an accessory portion of the principal building, for the private use of the owner or occupant of the principal building, designed or used for the storage and shelter of motor vehicles with no facilities for mechanical service or repair of a retail nature.

Garage, Public: shall mean a building or portion thereof, other than a private garage, designed or used for the care or storage of motor vehicles, or where such vehicles are kept for remuneration, hire or sale, but not including trucks, tractors, truck trailers or commercial vehicles exceeding one and one-half ton capacity.

Garden Center: shall mean a place of business where plants, nursery products, fertilizers, potting soil, garden tools and utensils are sold to the customer. The sales and storage of the merchandise is permitted in any open area which adjoins the building.

Gasoline Station: shall mean any building, land area, or other premises, or a portion thereof, used or intended to be used only for the retail dispensing or sale of motor vehicle fuels and fluids.

Gazebo: shall mean an open-air structure with a solid roof supported on posts or columns.

Group Home: shall mean a dwelling for four (4) or more persons not related by blood, marriage or adoption who live together as a single housekeeping unit, and which contains common cooking facilities and common living and eating areas. Group Homes include, but are not limited to, convents, residences for disabled persons, orphanages and monasteries. Group Homes do not include residences that serve as an alternative to incarceration for persons convicted of criminal offenses, or residences for persons whose primary reason for placement therein is the treatment of a communicable disease.

Habitable Space: shall mean space in a structure designed for living, sleeping, eating or cooking, but excluding bathrooms, toilet compartments, closets, halls, storage or utility spaces and similar areas.

Health Club: shall mean a facility designed for the major purpose of physical conditioning and fitness or weight reduction which includes, but is not limited to such equipment as free weights, weight resistance machines, cardiovascular machines, whirl pools, saunas, showers, lockers, swimming pools, or basketball and racquet courts. This shall not include recreation facilities owned or managed by the Sycamore Park District.

Health and Welfare Facility: shall mean a facility specializing in medical treatment, physical therapy (alcohol and drug treatment), assisted living for all ages, retirement communities, and shelters.

Height (for landscaping): shall mean reference to the total finished height of a structure or general mature height of plant materials installed above the adjacent elevation of soil or paving. Specified height of a screening may be provided by a berm, combination of a berm and planting, or a structure unless otherwise specified herein.

Home Improvement Center: shall mean an establishment where home improvement materials, including but not limited to, kitchen and bathroom accessories and fixtures, wall coverings, window coverings, heating and air conditioning, plumbing and electrical supplies, painting and decorating material, tools and residential construction and remodeling materials and supplies are sold for retail. Outdoor storage of building materials may be provided but is accessory to the principal use and structure and only as permitted by the district in which it is located.

Home-Occupation: Any occupation or profession carried on by a member of a family, residing on the premises, in connection with which no sign is used other than that allowed by the sign regulations for the district in which such home occupation is located; provided that no commodity is sold upon the premises except such as may be produced on the premises by members of the immediate family residing on the premises, and provided that no mechanical equipment is used except such as is normally used for domestic, hobby, or household purposes. Home Occupation shall include, but not be limited to, the use of such premises by a physician, surgeon, dentist, lawyer, clergyman, realtor, architect, financial advisor, or other

professional person. Medical professionals may receive clients for emergency treatment, but not for the general practice of their profession as in the case of clinics.

Hospital: shall mean an institution providing primary health services and medical or surgical care to in-patients suffering from illness, disease, injury, deformity and other abnormal physical or mental conditions and including as an integral part of the institution, related facilities such as laboratories, pharmacies, out-patient facilities or training facilities.

Hotel: shall mean a building designed for transient occupancy containing six (6) or more lodging rooms or guest rooms accessible from a common interior hall or entrance, providing living, sleeping and sanitary facilities. A central kitchen, meeting rooms, dining room and recreation room are generally provided.

Joint Solar Energy System: shall mean a solar energy system that supplies energy for structures or processes on more than one lot or in more than one condominium unit or leasehold, but not to the general public and involving at least two owners or users.

Junk Yard: shall mean an open area of land and any accessory building or structure thereon which is used for buying, selling, exchanging, storing, baling, packing, disassembling, or handling waste or scrap materials, including vehicles, machinery, and equipment not in operable condition or parts thereof, and other metals, paper, plastics, rags, rubber tires, and bottles. Two (2) or more inoperable motor vehicles stored on a zoning lot shall be considered a junkyard. A “junkyard” includes a motor vehicle wrecking yard, but does not include an establishment located in the applicable manufacturing district engaged exclusively in processing of scrap iron or other metals to be sold only to establishments engaged in manufacturing of steel or metal alloys.

kennel: shall mean any lot or premises, or portion thereof, whether public or private, on which five (5) or more dogs, cats, or other household domestic animals or any combination of five (5) or more of such animal species over four (4) months of age are kept, or on which more than two (2) such animals are maintained, boarded, bred, or cared for in return for remuneration or for the purpose of sale. Kennel (indoor) shall mean that the animals noted above will remain inside at all times unless supervised by an employee. (2014.18, 10-20-14)

Kiosk: shall mean an enclosed structure less than 200 square feet in area that is designed for providing specialty type retail services of either the drive through or walk up variety. These structures may be used to provide some type of limited service such as, but not limited to, the sale of coffees or shaved ices where water and sanitation can be provided by portable means. Employee restrooms must be provided in the kiosk or in an adjacent building on the same site as long as the restroom is accessible, available at all times that the kiosk is open, and within 300 feet of the kiosk.

Laboratory: shall mean a building, or portion thereof, in which scientific research, investigation, testing, analyzing, or experimentation is conducted on a regular basis but not devoted to the manufacturing of a product or products.

Large Brewery: shall mean an establishment where beer and malt beverages are made on the premises at an annual beer production rate of 15,000 barrels or more. See “Tap Room” for provisions governing on-site consumption.

Liquor Store: shall mean a place of business selling beer, wine and/or distilled liquors at retail, to the general public in sealed bottles or containers for consumption or use away from the premises where said establishment is located.

Livestock Animals: shall mean domesticated animals limited to horses, cattle, donkeys, mules, alpacas, llamas, sheep, hogs, goats and poultry.

Lot: shall mean land which is part of a subdivision, the plat of which has been recorded in the Office of the County Recorder of Deeds, of DeKalb

County or it may be and consist of a part of such recorded lot, or it may include parts of or a combination of several lots when adjacent to one another and used as one parcel.

Lot Area: shall mean the area of a horizontal plane bounded by the front, side and rear lot lines. Calculation of the required minimum lot area shall not include street right-of-way, whether dedicated to the public or a private street or easement for street purposes and, when adjacent a water course, drainage way, channel or stream, the area included in floodplain or easements reserved for the maintenance of said surface waters.

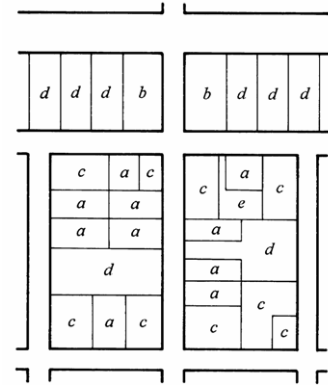

Lots:

- (a) Interior Lot
- (b) Gateway Lot
- (c) Corner Lot
- (d) Double Frontage Lot
- (e) Flag Lot

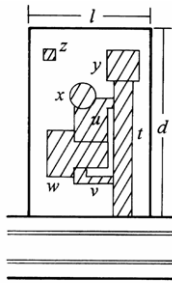

Lot, Corner: shall mean a lot which is situated at and abuts the intersection of two or more streets or adjoins a curved street at the end of a block.

Lot Coverage: shall mean the percentage of a zoning lot occupied by buildings, including accessory buildings and structures, driveways, sidewalks, decks, and patios.

Lot Coverage (m)

$$\text{where } m = \frac{(t + u + v + w + x + y + z)}{\text{area of lot } (l \times d)}$$

Lot Depth: shall mean the distance between the midpoints of the front lot line and the midpoint of the rear lot line.

Lot, Double Frontage: shall mean a lot which has its rear and front yard bordering on a street.

Lot, Flag: shall mean a lot with access provided to the bulk of the lot by a narrow corridor of property and the narrow corridor frontage is the only public street frontage.

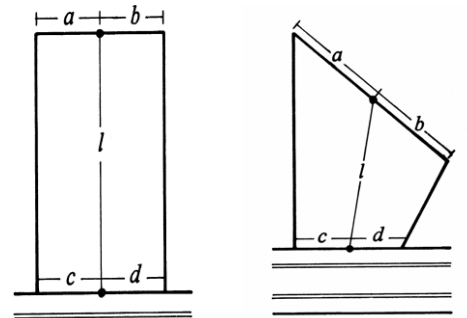

Lot Depth (l): where $a=b$ and $c=d$

Lot, Gateway: shall mean a lot which has its front, rear and one side yard bordering on a street.

Lot, Interior: shall mean a lot which has only its front yard bordering on a street.

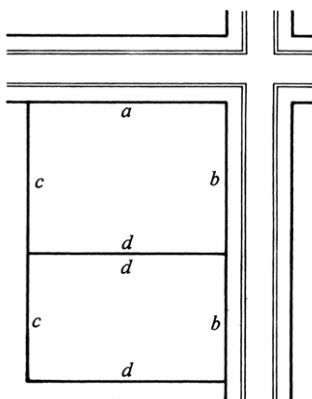

- Lot Lines:**
- (a) Corner Side Yard Line
 - (b) Front Yard Line
 - (c) Rear Yard Line
 - (d) Side Yard Line

Lot Lines: shall mean the lines bounding a lot as defined herein. On a corner lot, the Zoning Administrator shall designate which of the two lines abutting a street right-of-way shall be considered a corner lot line and which shall be considered a front lot line.

Lot Line, Front: shall mean a street right-of-way forming a boundary of a lot. On a corner lot, the Zoning Administrator shall designate which of the two lot lines abutting a street right-of-way shall be considered a front lot line and which shall be considered a side lot line.

Lot Line, Rear: shall mean a lot-line which is opposite and most distant from the front lot-line and, in the case of irregular lot lines, triangular or gore-shaped lots, a line ten feet in length within the lot, parallel to and at the maximum distance from the front lot-line.

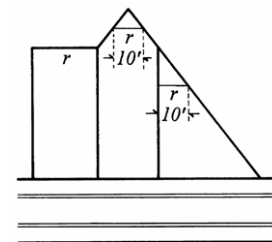

Rear Lot Line (r)

Lot of Record: shall mean a lot which is part of a subdivision, the plat of which has been recorded in the office of the DeKalb County Recorder of Deeds, or a legally created parcel of land, the deed to which is recorded in the office of said County Recorder.

Lot Line, Side: shall mean any lot boundary line not a front lot line or a rear lot line setback.

Lot Width: shall mean the horizontal distance between the side lot lines of a lot measured within the lot boundary along the front building line.

Lot, Zoning: shall mean a single tract of land under common ownership, wholly within the boundaries of the City/Village and on one side of a public street, and which has frontage on a public street or private drive approved as part of a subdivision, which is designated by its owner or developer as a tract to be used, developed or built upon as a unit, under single ownership or control and which meets all requirements of this Title. The division of a zoning lot may or may not result in the creation of two or more zoning lots, and a zoning lot(s) may or may not coincide with a lot of record.

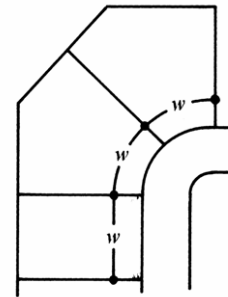

Lot Width (w)

Lounge: shall mean a room(s) accessory to the principal use of the building or tenant space in the building where alcoholic beverages are served for consumption on the premises and may provide for live entertainment on the premises.

Low Growing Shrubs: shall mean a woody shrub with a maintained or unmaintained average mature height of three (3) feet or less.

Lumber Yard: shall mean an establishment where the principal activity is the retail and wholesale sale of wood products and generally involving outdoor storage of building materials and supplies.

Manufacture: shall mean an economic activity engaged in the mechanical or chemical transformation of materials or substances, including the assembling of component parts, the manufacturing of products and the blending of materials such as lubricating oils, plastics, resins or liquors, into new products.

Manufacturing: shall mean the mechanical or chemical transformation of materials or substances into new products including the assembling of components; parts, the manufacturing of products and the blending of materials.

Massing: shall refer to the shape and form a building takes on through architectural design. There are ten (10) architectural design elements which create urban space. A specific project need not incorporate all ten elements: (1) building silhouette—a similar pitch and scale to roof line; (2) spacing between building facades; (3) setback from property line; (4) proportion of windows, bays, and doorways and vertical or horizontal elements tied together in bands across the façade length; (5) proportion of primary façade in relation to nearby facades similar in area and height-to-width ratios; (6) location and treatment of entryway; (7) materials used in the building's exterior; (8) building scale; (9) landscaping; and, (10) shadow patterns form decorative features with the light and dark surfaces from materials used and projections form window bays and create visual breaks.

Medical Office/Clinic: shall mean an establishment where two or more licensed doctors of medicine engage in the practice of medicine, operating on a group or individual basis with pooled facilities such as coordinated laboratory, x-ray and allied departments, for the diagnosis and treatment of humans, and may include a drug prescription counter (not a drug store) for dispensing prescription drugs and pharmaceutical products to the patients of said medical.

Medical Cannabis Cultivation Center: shall mean a facility operated by an organization or business that is registered by the Department of Agriculture to perform necessary activities to provide only registered medical cannabis dispensing organizations with usable medical cannabis, in accordance with the

Compassionate Use of Medical Cannabis Pilot Program Act, enacted by the State of Illinois effective January 1, 2014, as may be amended from time to time.

Medical Cannabis Dispensing Organization: shall mean a facility operated by an organization or business that is registered by the Department of Financial and Professional Regulation to acquire medical cannabis from a registered cultivation center for the purpose of dispensing cannabis, paraphernalia, or related supplies and educational materials to registered qualifying patients, in accordance with the Compassionate Use of Medical Cannabis Pilot Program Act, enacted by the State of Illinois effective January 1, 2014, as may be amended from time to time.

Metal Products, Fabricated: shall mean the process of forging, stamping, bending, forming, machining, and shaping metal products.

Microbrewery: shall mean an establishment where beer and malt beverages are made on the premises and then sold or distributed, and which produces less than 15,000 barrels of beer per year (a barrel is approximately 31 gallons). Microbreweries sell to the public by one or more of the following methods: the traditional three-tier system (brewer to wholesaler to retailer to consumer); the two-tier system (brewer acting as wholesaler to retailer to consumer); and directly to the consumer through carry-outs and/or on-site tap-room sales. See "Tap Room" for provisions governing on-site consumption.

Mini-Mart, Motor Vehicle: shall mean a gas station which offers or includes as an accessory use, the retail sale of merchandise or services not related to dispensing fuel, the maintenance, service or repair of motor vehicles.

Minimum Contiguous Area: shall mean the area that may constitute a separate or detached part of any zoning district classification as set forth in this Ordinance.

Mobile Home: A mobile structure of vehicular, portable design, built on a chassis and designed to be movable from one site to another, and to be used with or without a permanent foundation. Mobile units placed on permanent foundations must be designed and constructed to comply with all of the requirements of the locally-adopted building codes for prefabricated construction.

Mobile Home Park: An area on which two or more mobile homes are parked, excluding sales lots.

Motel: shall mean a building offering transient occupancy containing lodging rooms directly accessible from an exterior hall or entrance, providing living, sleeping and sanitary facilities, whether such establishment is designated as a hotel, inn, automobile court, motor inn, motor lodge, tourist court, or otherwise.

Nightclub: shall mean an establishment where alcoholic beverages are served for consumption on the premises and live entertainment is provided. The establishment may provide for dancing and a menu for prepared food items during hours of operation.

Nursery: shall mean a land or structure(s) or a combination used to raise flowers, shrubs, trees, and other plant material for sale.

Nursery School: See **Day Care Center**.

Nursing Home: shall mean an extended or intermediate care facility licensed or approved to provide full-time convalescent or chronic care to individuals who by reasons of advanced age, chronic illness or infirmity are unable to care for themselves.

Office: see **Professional Office**.

Ornamental Tree: shall mean a tree with an unmaintained average mature height less than twenty (20) feet. Flowers, spring and fall color, and interesting growth habits are characteristics of these trees.

Overlay District: shall mean a set of regulations which add an additional layer of design provisions to an underlying zoning district.

Parking Area, Public: shall mean an open area other than a street or alley, used for the temporary parking of more than four (4) automobiles or commercial vehicles, and available for public use, whether free, for compensation, or as an accommodation for clients, customers or employees.

Patio: shall mean a level, unenclosed surfaced area located at grade and usually directly adjoining or attached to a building.

Pergola: shall mean a parallel colonnade consisting of posts, pillars or columns that support an open roof structure that is composed of girders and cross-rafters and that may support climbing plants or vines.

Personal Wireless Service: See Section 6.2.1,D,3 herein.

Personal Wireless Service Facility: See Section 6.2.1,D,3 herein.

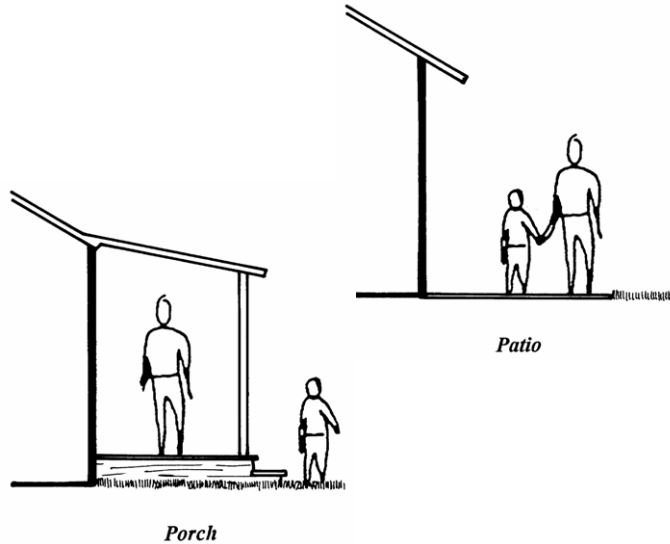

Porch: shall mean a roofed platform projecting from the wall of a building and having direct access to or from the building to which it is attached. A porch has no solid walls other than the wall of the building to which it is attached. A porch may be enclosed with a mesh screen to keep out unwanted insects but is otherwise exposed to the elements throughout the year.

Porch and Fence: shall mean a building frontage type where the building façade is set back substantially from the frontage line and the porch encroaches in the setback.

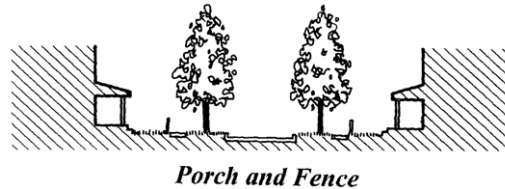

Professional Office: shall mean any office used primarily for accounting, engineering, legal, consulting, correspondence, editing, administration and related services.

Property Owners Association: shall mean a private, not-for-profit corporation of property owners that operates and maintains various common properties in a subdivision or development.

Queuing Space: shall mean the reservoir space occupied by any number of cars that must be accommodated while awaiting ingress or egress to specified business or service establishments.

Recess Line: shall refer to matters of spatial definition and shall mean a line prescribed for the full width of the façade, above which the façade is set back. Also see, *Transition Line*.

Recovery/Sober Living Home: Shall mean a monitored residence for individuals suffering from substance abuse issues whose primary reason for placement therein is to facilitate their reintegration into society as an alternative to incarceration or conviction of criminal offenses related to substance abuse, as determined by a judge or prosecutor. Sober living homes shall house not more than eight (8) adult persons not related by blood, marriage or adoption who live together as a single housekeeping unit. Any recovery house shall contain adequate space for common cooking facilities and common living and eating areas. Sober living homes shall not include residences for persons whose primary reason for placement therein is the treatment of communicable diseases. The definition and criteria to establish a recovery home is outlined in Section 2060 of the Illinois Administrative Code.

Recreational Vehicle: shall mean any vehicle or boat originally designed for living quarters, recreation, or human habitation and not used as a commercial vehicle, including, but not limited to, the following: (i) *Boats* -- meaning any vessel used for water travel, a boat mounted on a trailer shall be considered one vehicle; (ii) *Camping Trailers* -- meaning a folding or collapsible vehicle without its own motive power, designed as temporary living quarters for travel, camping, recreation or vacation use; (iii) *Motor Homes* -- meaning a temporary dwelling designed and constructed for travel, camping, recreational or vacation use as an integral part of a self-propelled vehicle; (iv) *Off-Road Vehicles* -- meaning vehicles intended primarily for recreational use off of roads where state vehicle licenses are required, e.g. dune buggy, go-cart, snow mobile; (v) *Racing Car/Cycles* -- meaning vehicles intended to be used in racing competition, such as a race car or racing cycle, a racing car/cycle mounted on a trailer shall be considered one vehicle; (vi) *Travel Trailers* -- meaning vehicles without its own motive power, designed to be used as a temporary dwelling for travel, camping, recreational or vacation uses; (vii) *Truck Campers* -- meaning a structure designed primarily to be mounted on a pick-up truck or truck chassis and designed to be used as a temporary dwelling for travel, camping, recreational or vacation uses, when mounted on a truck, such structure shall be considered one vehicle; (viii) *Vans* -- meaning noncommercial motor vehicles licensed by the State of Illinois as a Recreational Vehicle; and (ix) *Vehicle Trailers* -- meaning a vehicle without its own motive power that is designed to transport another vehicle, such as a boat, motorcycle or snowmobile for recreational or vacation use and that is eligible to be licensed or registered and insured for highway use, a vehicle trailer with a vehicle mounted on it shall be considered one vehicle.

Recycling Center: shall mean a facility that is not a junkyard, in which recoverable resources from used materials and products are purchased, collected, processed to a condition for reuse, or temporarily stored prior to sale to others who will use the recovered resources to manufacture new products.

Recycling Collection Center: shall mean a building or a portion thereof in which recoverable resources from used products and materials are collected and temporarily stored prior to delivery or sale to others who will process the recoverable resources.

Remodel, remodeling: shall mean to remake, redecorate the interior or exterior of a structure without making structural alterations.

Repair Facility, Motor Vehicle: shall mean any building, or portion thereof, used for the repair or replacement of engines, transmissions, differentials, drive trains, or any part thereof, in addition to the replacement of parts, service and incidental repairs to motor vehicles, but excluding operations specified under "body shop."

Restaurant: shall mean any building or part thereof where a menu of food items are cooked and prepared for compensation, for the general public for immediate consumption on and/or off the premises, including any part of such building or part thereof which may be used for dining by the general public. The retail sale of beer, wine and other alcoholic beverages for consumption on the premises and dancing may be provided on the premises. Reheating of already prepared food by microwave and/or the selling of already prepared food for consumption off premises does not constitute a restaurant.

Rest Home: See **Convalescent Home.**

Right-of-Way, Public: shall mean the land opened, reserved, or dedicated for a street, sewer, water, walk, drainage course, or other public purpose.

Roadside Stand: shall mean a structure for the display and sale of agricultural products, with no space for customers within the structure.

Rooming House: shall mean a building or portion thereof converting a room or suite of rooms rented as sleeping and living quarters, but without cooking facilities and with or without an individual bathroom for compensation.

Sanitarium: See **Hospital**.

Satellite Station: shall mean any disc antenna with an essentially solid surface, whether flat, concave, or parabolic which is designed for receiving television, radio or electromagnetic or microwave signals from satellites or other satellite stations.

School, Commercial: shall mean a school which principally offers, for profit, specific courses of instruction in business, trade, industry or other trained skills, but does not offer academic instruction equivalent to the standards prescribed by the School Code of Illinois.

School, Private: shall mean an institution conducting regular academic instruction at kindergarten, elementary, junior high and senior high school levels, operated by non-governmental organizations, which programs are accepted by the State of Illinois in lieu of public instruction. This shall not include private commercial schools.

School, Public: shall mean a public institution conducting regular academic instruction at the kindergarten, elementary, junior high and senior high school levels equivalent to the standards prescribed by the School Code of Illinois.

Screen: shall mean a structure or planting composed of sufficient material to obstruct vision beyond the screen. Generally, but not always, a screen is intended to provide in excess of ninety-percent (90%) opaque obstruction to vision during all seasons of the year.

Self-Service Storage (Indoor): shall mean a building that contains at least 10,000 square feet of various sizes of interior climate-controlled individual, compartmentalized, and controlled access stalls or lockers for the storage of customer's goods or wares. All units shall only be accessible from an interior hallway. No exterior access to storage units, outdoor storage, or storage of flammable or combustible liquids or gases is allowed.

Self-Service Storage (Outdoor): shall mean a building or group of buildings in a controlled access and fenced compound that contains various sizes of individual, compartmentalized, and controlled access stalls or lockers for the storage of customer's goods or wares.

Service Facility, Motor Vehicle: shall mean an establishment where gasoline or other motor fuel, lubricating oil or grease, or fluids for operating or protecting motor vehicles, or accessories to provide added value and convenience to the owner of the vehicle are offered for sale to the public and servicing vehicles with such products is performed on the premises.

Septic System: shall mean an underground system with a septic tank used for the discharge of domestic sewage waste.

Service Station: shall mean a gasoline station, a portion of which is used for the repair or replacement of engines, transmissions, differentials, drive trains or any part thereof, in addition to the replacement of parts, service and incidental repairs to motor vehicles, but excluding operations specified under "motor vehicle body shop."

Setback: shall refer to matters of spatial definition and shall mean the mandatory distance between a frontage line and a façade, or a lot line and an elevation.

Shade Tree: shall mean a large tree of standard growth habit with an average mature height in excess of twenty (20) feet. The main purpose of this type of tree in landscape designs is to provide shade and scale against buildings.

Shed: shall mean a detached accessory structure twenty-five (25) square feet or more in floor area used for domestic storage purposes.

Shop Front: shall mean a building frontage type where the building façade is aligned directly on the frontage line with the building entrance at grade.

Shopping Center: shall mean a group of more than five (5) business establishments planned, developed and managed as a unit, located on the same lot with off-street parking provided on the property.

Shrub: shall mean a branched woody plant with an unmaintained average mature height less than eight (8) feet.

Sign: shall mean every device, frame, letter, figure, character, mark, plane, point, design, picture, stroke, stripe, trademark, or reading matter, which is used or intended to be used to attract attention or convey information when the same is placed in view of the general public.

Site, Building: shall mean the ground area of a building or a group of buildings together with all open spaces as required by this Ordinance.

Sight Triangle: shall mean a triangular area established on private property at the intersection of two (2) streets or a street and a driveway in which nothing shall be erected, planted, or allowed to grow so as to limit or obstruct the sight distance of motorists and pedestrians.

Solar Collector: shall mean (i) An assembly, structure, or design, including passive elements, used for gathering, concentrating, or absorbing direct or indirect solar energy, specially designed for holding a substantial amount of thermal energy and to transfer that energy to a gas, solid, or liquid or to use that energy directly; or (ii) A mechanism that absorbs solar energy and converts it into electricity; or (iii) A mechanism or process used for gathering solar energy through wind or thermal gradients; or (iv) A component used to transfer thermal energy to a gas solid, or liquid, or to convert it into electricity.

Solar Energy: shall mean radiant energy received from the sun at wavelengths suitable for heat transfer, photosynthetic use, or photovoltaic use.

Solar Energy System: shall mean (i) a complete assembly, structure, or design of a solar collector, or a solar mechanism, which uses solar energy for generating electricity or for heating or cooling gases, solids, liquids, or other materials; (ii) the design, materials, or elements of a system and its maintenance, operation, and labor systems designed or constructed to interface with a solar energy system; and, (iii) any legal, financial, or institutional orders, certificates, or mechanisms, including easements, leases, and agreements, required to ensure continued access to solar energy, its source, or its use in a solar energy system, and including monitoring and educational elements of a demonstration project. Solar Energy System does not include (i) Distribution equipment that is equally usable in a conventional energy system except for such components of such equipment as are necessary for meeting the requirements of efficient solar energy utilization; (ii) Components of a solar energy system that serve structural, insulating, protective, shading, aesthetic, or other non-solar energy utilization purposes, as defined in the regulations of the Department; and, (iii) Any facilities of a public utility used to transmit or distribute gas or electricity.

Solar Storage Mechanism: shall mean equipment or elements (such as piping and transfer mechanisms, containers, heat exchangers, or controls thereof, and gases, solids, liquids, or combinations thereof) that are utilized for storing solar energy, gathered by a solar collector, for subsequent use.

Stoop: shall mean a building frontage type where the building façade is aligned directly on the frontage line with the ground floor elevated to provide secure privacy at the windows.

Storage Enclosure: shall mean an accessory structure less than twenty-five (25) square feet in floor area used for domestic storage purposes and located directly adjacent to the principal structure.

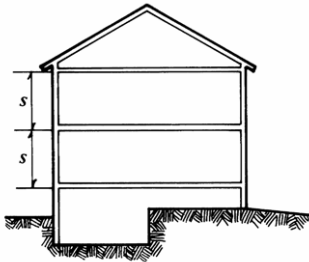

Story (s)

Story: shall mean that portion of a building included between the surface of any floor and the surface of the floor next above; or if there is no floor above, the space between the floor and the ceiling next above.

Street: shall mean the paved or unpaved portion of a public or private right-of-way, other than an alley which affords principal means of vehicular access to abutting property.

Street, Local: shall mean a street of limited continuity used primarily for access to abutting properties and designated "Non-Arterial" by the Public Works Director.

Street Tree: shall mean a tree of standard growth habit acceptable to the City of Sycamore for installing within the public right-of-way.

Street Orientation: shall mean the direction of the architectural front façade of a building in relation to the street.

Structural Alteration: shall mean any change or modification, other than incidental repairs or which are required by provisions of this Title, which would prolong the life of the supporting member of a structure such as bearing walls, columns, beams, girders or foundations.

Structure: shall mean anything erected, the use of which requires more or less permanent location on or in the ground or attached to something having a permanent location on or in the ground, including, for example, buildings, towers, antennae, freestanding signs, fences, decks, garden sheds and swimming pools.

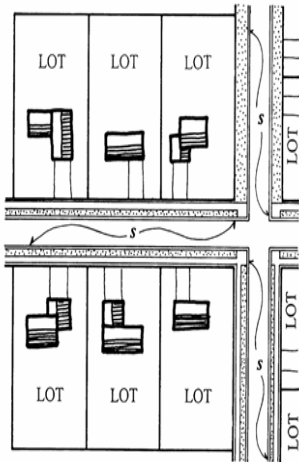

Street (s)

Swimming Pool: shall mean a structure designed to hold water and maintain a water depth of twenty-four (24) inches or more, but not including hot tubs or wading pools.

Tap Room: shall mean a room that is ancillary to the production of beer at a microbrewery or large brewery where the public can purchase and/or consume only the beer produced on site. A tap room shall be oriented to the street or the main pedestrian entrance of the building. A minimum of 500 square feet shall be provided for any tap room.

Terminal, Bus: shall mean a building or area specifically designated for the assembly and boarding and unboarding of passengers to/from a bus.

Terminal, Motor Freight: shall mean a building or an area in which freight brought by truck is assembled and/or temporarily stored for routing or reshipment, or in which semi-trailers, including tractor and/or trailer units and other trucks, are parked or stored.

Terrace: shall mean a landscape treatment of mounded earth, rock wall, railroad tie wall or other retaining device used to modify steep grade differences on a lot. A terrace shall not include a patio or deck surface.

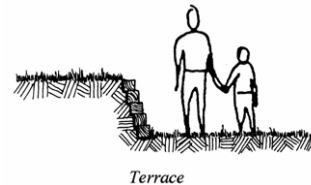

Townhouse: a single-family dwelling unit constructed in a group of three or more attached units in which each unit extends from the foundation to the roof and has open space on at least two sides.

Tract: is used interchangeably with the term "lot", particularly in the context of subdivisions, where one "tract" is subdivided into several "lots".

Trailer: shall mean any structure built on a chassis for licensing by the Secretary of State as a trailer and designed for general hauling or recreational purposes.

Transition Line: shall refer to matters of spatial definition and shall mean a line prescribed for the full width of the façade, expressed by a variation of material or by a limited projection such as a cornice or a balcony.

Tree Survey: shall mean a scaled drawing accurately locating and indicating the size, condition and specie (common and botanical names) of all trees having a caliper of four (4) inches or larger, and the location of any buildings, parking areas, sidewalks and streets on a parcel of property.

Use: shall mean the purpose or purposes for which land, buildings or structures is (are) designed, arranged or intended, or for which they are or may be occupied or maintained.

Use, Conforming: shall mean any use of land, buildings or structures which conforms with the list of permitted uses of the zoning district in which the land, building or structure is located, or which is governed by an active Special Use Permit authorized by the City Council. If the use is a permitted use but does not conform with the intensity of use regulations of the district in which it is situated, then the use shall not be deemed to be a conforming use.

Use, Non-Conforming: shall mean any building or structure or use of any building or structure or tract of land, lawfully existing or under construction at the time of adoption of this Title or of a later amendment, but does not conform with one (1) or more of the requirements or restrictions of this Title.

Variation: shall mean a modification of the application of this Title in specific cases where practical difficulties or particular hardships, not intended or not common to other property owners in the district, would result from following the strict letter of the Title.

Veterinary Clinic: shall mean an establishment where one or more licensed veterinarians engage diagnosing or medically treating animals that are accommodated on the premises.

Veterinary Hospital: shall mean an establishment where one or more licensed veterinarians engage in diagnosing or surgically treating animals that may or may not be accommodated within the interior of the premises.

Wall, Common: shall mean an interior wall that separates and distinguishes two (2) or more uses located in the same building or structure. A common wall extends from floor to ceiling and from exterior wall to exterior wall, and conforms to the fire resistance requirements of the City's Building Code.

Warehouse: shall mean a structure, or part thereof, or area used principally for the storage of goods and merchandise.

Warehouse and Distribution Center: shall mean a building used in the storage, wholesale, and distribution of manufactured products, supplies, and equipment, but excluding bulk storage of materials that are flammable or explosive or that create hazardous or commonly recognized offensive conditions.

Wholesale Establishment: shall mean a business establishment principally engaged in selling to retailers or distributors rather than consumers.

Wireless Communication Facility: See Section 6.2.1.3 herein.

Wrecking Yard, Vehicle: shall mean a lot or any portion of a lot where two (2) or more motor vehicles or trailers which, for a period of thirty (30) days, have not been capable of operating under their own power, and from which parts have been or are to be removed for sale or reuse, or any land, buildings, or structures used for the wrecking, dismantling, salvage, sale or storage of such motor vehicles, trailers or the parts thereof.

Yard: shall mean an open space on a lot which is unoccupied and unobstructed from its lowest level to the sky, except for permitted yard obstructions, and which extends along a lot line and at right angles or radial thereto to a depth or width specified in the yard regulations for the district in which the zoning lot is located.

Yard, Corner Side: shall mean a yard extending the full length of a corner side lot line and back to a line drawn parallel to the corner side lot line at a distance equal to the required corner side yard depth.

Yard, Front: shall mean a yard extending along the full length of a front lot line and back to a line drawn parallel to the front lot line at a distance equal to the required front yard depth.

Yard, Rear: shall mean a yard extending along the full length of a rear lot line and back to a line drawn parallel to the rear lot line at a distance therefrom equal to the required rear yard depth, but excluding any area encompassed within a required corner side yard.

Yard, Side: shall mean a yard extending along the full length of a side lot line and back to a line drawn parallel to the side lot line at a distance equal to the required side yard, depth, but excluding any area encompassed within a required front yard or rear yard.

Yard, Transition: shall mean the required front, side, corner side or rear yard on a lot in a commercial or industrial district and an adjoining residential district, or the required front, side, corner side or rear yard for a non-residential use and adjoining residential uses in a residential district, except when such yard is adjacent a railroad right-of-way, alley or street.

Zone: See **District, Zoning.**

Zoning Administrator: shall be appointed by the City Manager to enforce this Ordinance.

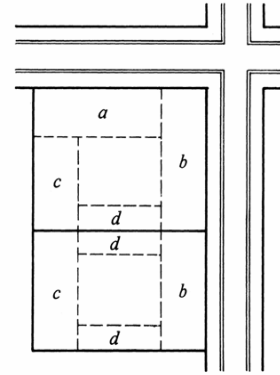

Yards:

- (a) Corner Side Yard
- (b) Front Yard
- (c) Rear Yard
- (d) Side Yard

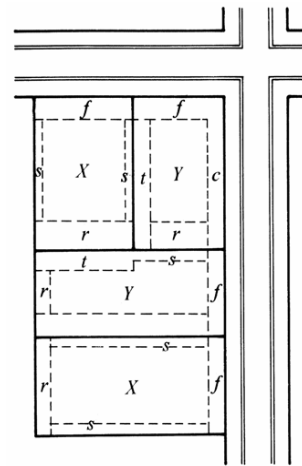

Transition Yards (t)

Where
X = residential lot, and
Y = non-residential lot

f = Front Yard
c = Corner Side Yard
s = Side Yard
r = Rear Yard